

RCWL-0516

RCWL-0516 microwave radar sensor module Human body induction switch module Intelligent sensor

Features:

- 1, transmission signal processing control chip **RCWL-9196**
- 2, wide operating voltage range: 4.0-28.0V
- 3, compared with the traditional infrared feeling PIR, with the penetrating detection capability
- 4, block time, distance adjustable
- 5, output 3.3V power supply

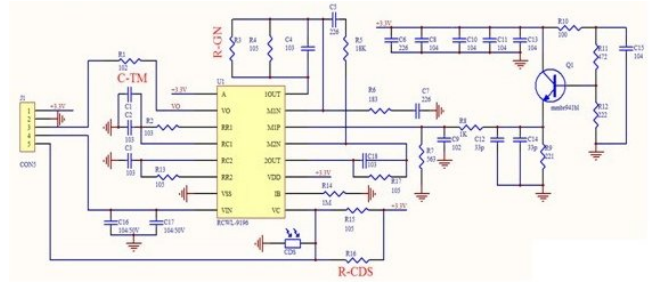
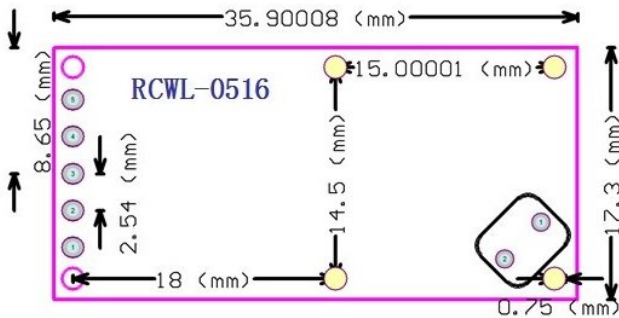

Application Design Note:

- 1, the sensing face in front of the gold without any shelter.
- 2, front and rear sensing surface space to set aside more than 1CM
- 3, the module carrier plane and install as flat line
- 4, a certain application of effective detection area
- 5, the component side of the module is positive sensing face, the opposite is negative sensing surface. Negative sensing surface sensing less effective
- 6, microwave modules can not be large-scale applications in the same area, otherwise there will be mutual interference. Between single individuals over distance greater than 1M

RCWL-0516 is a doppler radar microwave motion sensor module which can act as an alternative to a PIR motion sensor. This git repository is an attempt to collect the rather scant information on this board in one place.

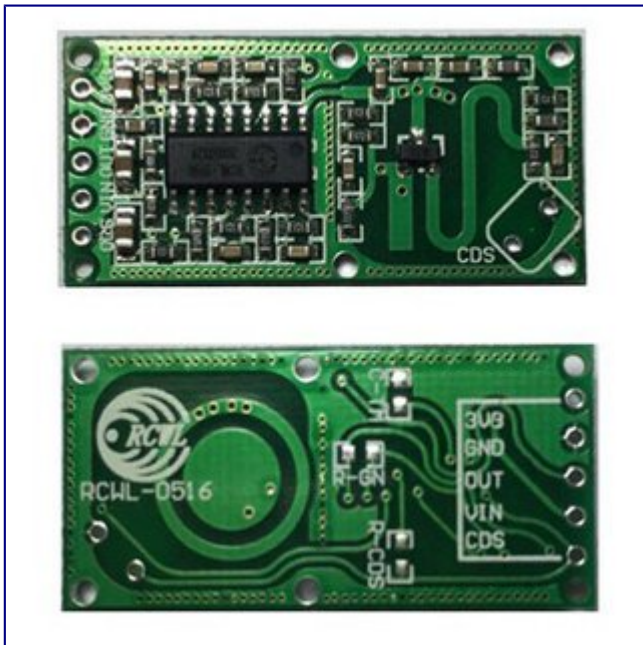

The unit I have was supplied by IC station (SKU 10630): <http://www.icstation.com/rcwl-0516-microwave-motion-sensor-module-radar-sensor-body-induction-module-100ma-p-10630.html> (Use coupon code 'joeics' for a 15% discount).

Operating frequency: The product specification omits the operating frequency. I found a carrier at 3.181GHz on my unit using a HackRF One SDR radio (see spectrum plot below). I suspect this frequency will vary from device to device: it would be difficult to have a tight specification with such a simple RF circuit on FR4 PCB.

Working voltage: 4 - 28V. It provides a convenient 3.3V output to drive a MCU (good for 100mA ?).

The forward side of the board is the side with components. This side should face the objects being detected. Do not obstruct forward side with anything metallic. The back side should have clearance of more than 1cm from any metal.

Board header

Pin	Function
3V3	3.3V regulated output. Max 100mA (?)
GND	Ground
OUT	Trigger: high (3.3V) if motion detected. 0V normally.
VIN	4 - 28V supply voltage
CDS	(light sensor related.. TODO)

Schematic

The only schematic I could find is very low resolution and it's hard to make out some of the text. However I've been reverse engineering it and adding my annotations.

There are two parts to this schematic. A microwave frequency transmitter/receiver/mixer and a much lower frequency part based on an IC (marked RCWL-9196) which is very similar to the BISS0001 IC used in PIR motion detectors.

First the microwave part:

The best explanation of how the microwave part of this works is in patent [EP3091605A1](https://patents.google.com/patent/EP3091605A1). It describes as similar type of module operating at 5.8GHz.

Annotated by
Joe Desbonnet
Rev 2017-01-06b

RCWL-0516

"RCWL-0516 microwave induction module" (Google Translate)

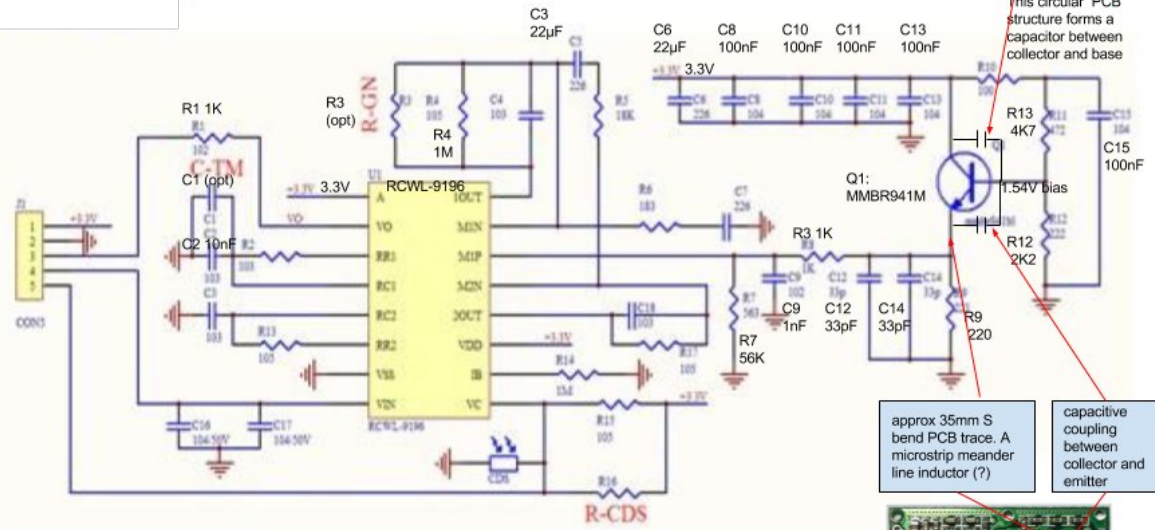

approx 35mm S bend PCB trace. A microstrip meander line inductor (?)

capacitive coupling between collector and emitter



BISS0001

"Note that U1 except pin 8 remaining pins are compatible with the BISS0001; their function is also compatible." (Google Translate)

At the heart of the RF is a Q1 a MMBR941M high frequency NPN transistor [5] in what is probably a [Colpitts oscillator](#) [6] configuration. The schematic above is misleading because it omits a key inductor and capacitors constructed from PCB traces (a microline inductor and capacitor). The inductor is the S curve trace on the top surface and capacitors are the ring structure on the bottom surface and also the rectangular block to the left of the S curve. Using the formula at reference [12] below I calculate the inductance of the S curve to be (very approximately) 10nH.

A critical function of a doppler radar is to be able to 'mix' the reflected signal with the transmitted signal to arrive at a frequency which is the difference between the transmitted and reflected signal.

In this board Q1 also cleverly assumes the function of the mixer: [TODO: this really needs to be explained].

The low doppler frequency difference is extracted by a low pass RC filter (C9 = 1nF, R3 = 1k, $f_c = 1/2\pi RC \approx 160\text{kHz}$) and amplified by the RCWL-9196 IC and treated exactly the same as a signal from a PIR sensor.

Update 4 Jan 2017: finally found the signal at 3.181GHz with the HackRF One SDR!

One interesting observation: waving my hand in front of the sensor causes significant changes in the transmitting frequency, shifting by up to 1MHz.

My theory: the low frequency doppler shift causes small changes in the transistor base bias.

I used spice simulations to verify that small changes to transistor base bias causes changes in oscillation frequency. By running a few simulations I estimate that 1µV change in bias will change oscillation frequency by 1.4MHz.

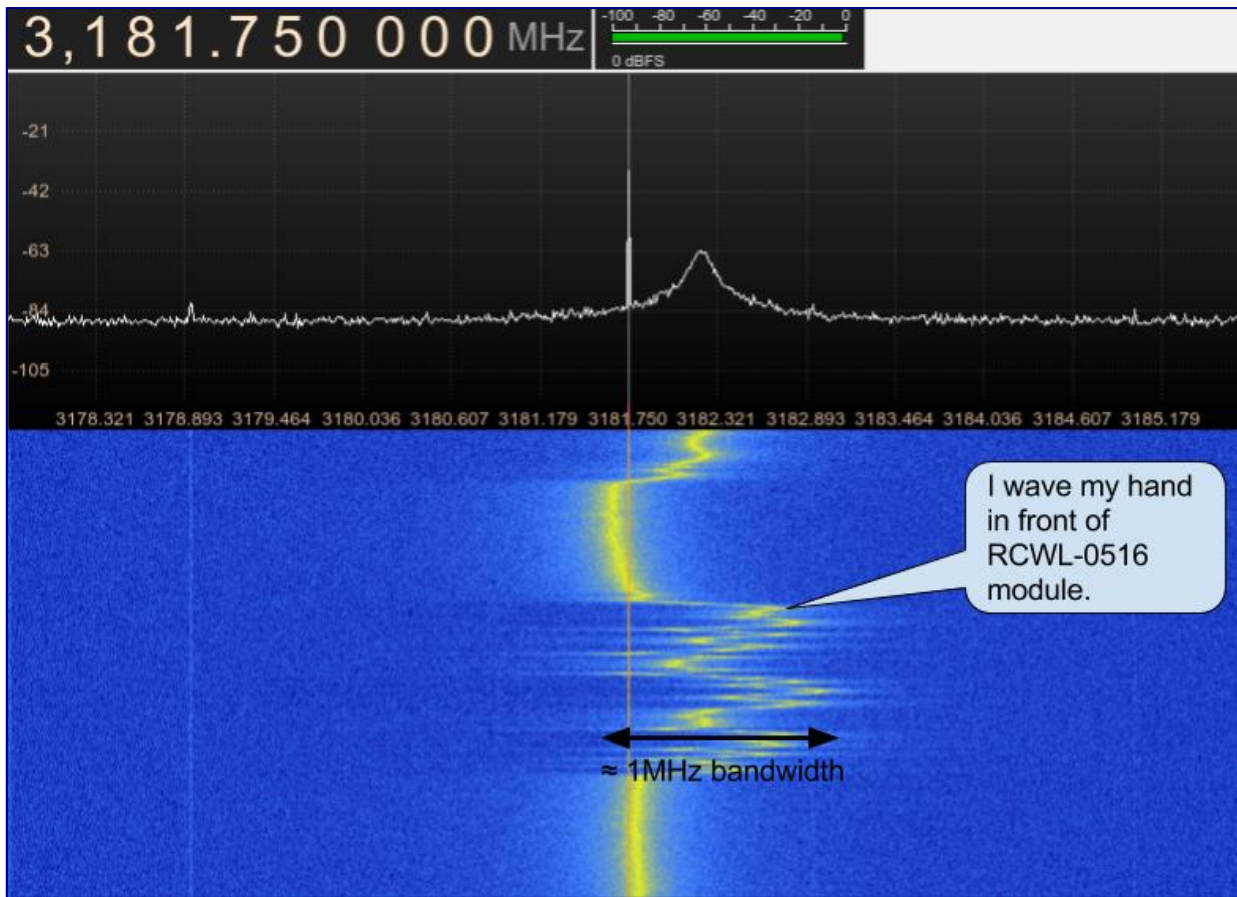

The low frequency part

The core of the low frequency signal processing is an IC marked RCWL-9196. The schematic says (in chinese) that it's similar to a BISS0001 PIR IC. But there are differences. Unfortunately I can't find any hard information (eg datasheet) on this. Now can I find any information on the brand/company name "RCWL".

Pin number	BISS0001	RCWL-9196
1	A Retriggerable & non-retriggerable mode select (A=1 : re-triggerable)	3.3V regulated output (100mA max?)
2	VO Detector output pin (active high)	same
3	RR1 Output pulse width control (Tx)	same?
4	RC1 Output pulse width control (Tx)	same?
5	RC2 Trigger inhibit control (Ti)	same?
6	RR2 Trigger inhibit control (Ti)	same?
7	Vss Ground	same
8	VRF RESET & voltage reference input (Normally high. Low=reset)	Vin (4 - 28V)
9	VC Trigger disable input (VC > 0.2Vdd=enable; Vc < 0.2Vdd =disabled)	same
10	IB Op-amp input bias current setting	?
11	Vdd Supply voltage	3.3V regulated output (again?)
12	2OUT 2nd stage Op-amp output	same
13	2IN- 2nd stage Op-amp inverting input	same
14	1IN+ 1st stage Op-amp non-inverting input	same
15	1IN- 1st stage Op-amp inverting input	same
16	1OUT 1st stage Op-amp output	same

Adjustment components

On the back of the board (the side without components) are pads for 3 optional components (0805 dimensions).

Pad	Function
C-TM	Regulate the repeat trigger time. The default (unpopulated) time is 2s. A SMD capacitor to extend the repeat trigger time. Pin 3 of the IC emits a frequency (f), and the trigger time in seconds is given by $(1/f) * 32678$
R-GN	The default detection range is 7m, adding a 1M resistor reduces it to 5m
R-CDS	the VCC is in parallel connection with CDS(RCWL-9196 pin 9) through R-CDS. Connect the LDR at the R-CDS to turn off the detecting function at night. (?? TODO: make sense of this)

Spice simulation

I started with an example Colpitt circuit [9] and substituted the 2N3904 NPN with a MMBR941 (Spice model from [10]). I am using the Windows LTSpice from Linear Technologies (available as free download [11], also works with Linux under Wine emulator). See [colpitt.asc](#) for a working Colpitt oscillator and [rcwl-0516.asc](#) for a model of the RCWL-0516 (however it does not oscillate!).

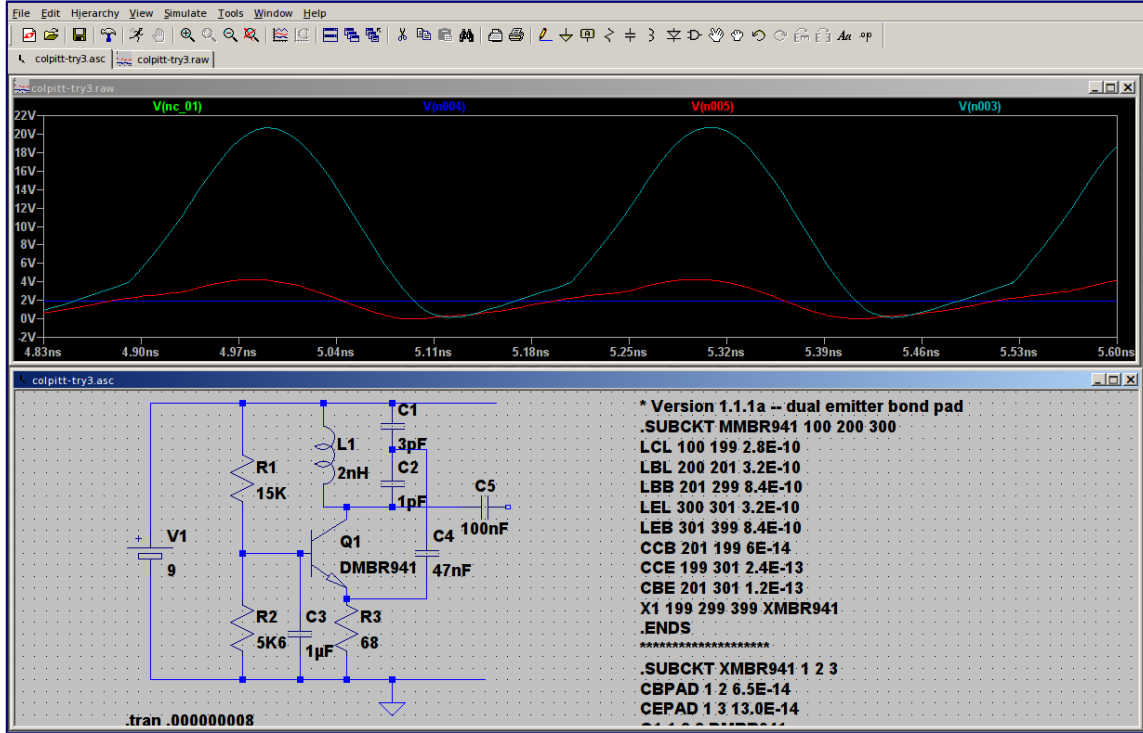

Doppler effect calculations

If f_t is the transmitted frequency, f_r is the reflected frequency (as measured by the common transmit/receive antenna on the sensor), v is the speed of the target relative to the sensor (negative if receding, positive if advancing toward sensor), c is the speed of light and $f_d = (f_r - f_t)$ is the doppler shift, then:

$$f_r = f_t (c + v) / (c - v)$$

$$f_d = f_r - f_t = 2v f_t / (c - v)$$

$$\text{If } (c \ll v) \text{ then } f_d \approx 2v f_t / c$$

Assume typical human motion speed of $v = 1 \text{ m/s}$, $f_t = 3.181 \text{ GHz}$, $c = 2.998 \times 10^8 \text{ m/s}$, then $f_d = 10 \text{ Hz}$.

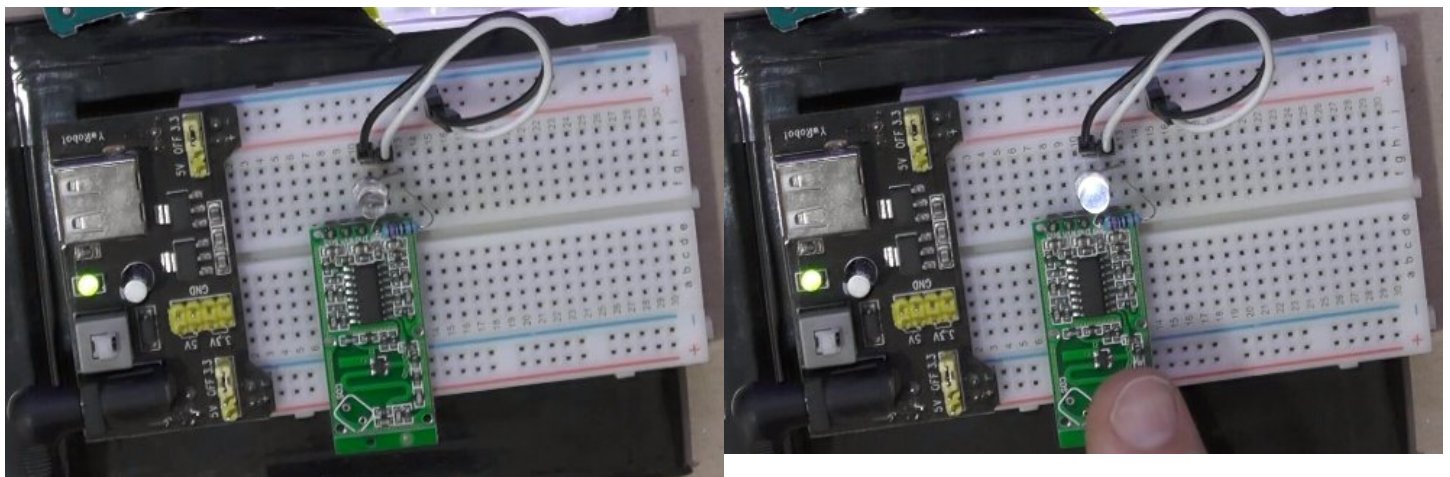

`/** Example NOT tested : Log the output pin of a RCWL-0516 radar module to a 433 MHz XY-FST transmitter. */`

```
#include <VirtualWire.h>
```

```
#define PIN_RADAR 2
```

```
#define PIN_TX 9
```

```
#define PIN_LED 13
```

```
void setup() {
  Serial.begin(9600);
  pinMode(PIN_LED, OUTPUT);
  vw_set_tx_pin(PIN_TX); // Arduino pin to connect the receiver data pin
  vw_setup(6000); // bps connection speed
}
```

```
int rv = -1;
```

```
void loop() {  
  digitalWrite(PIN_LED, HIGH);  
  int v = digitalRead(PIN_RADAR);  
  if (v != rv) {  
    rv = v;  
    char msg[20];  
    sprintf(msg, "R %lu %d", millis() / 1000, v);  
    vw_send((uint8_t *)msg, strlen(msg));  
    Serial.println(msg);  
    vw_wait_tx();    // Wait to finish sending the message  
  }  
  digitalWrite(PIN_LED, LOW);  
  delay(100);  
}
```

p.s. more info

<http://www.icstation.com/rcwl-0516-microwave-motion-sensor-module-radar-sensor-body-induction-module-100ma-p-10630.html>